

Sew and No Sew Instructions

(Courtesy of CDC website: <https://www.cdc.gov/coronavirus/2019-ncov/prevent-getting-sick/diy-cloth-face-coverings.html>)

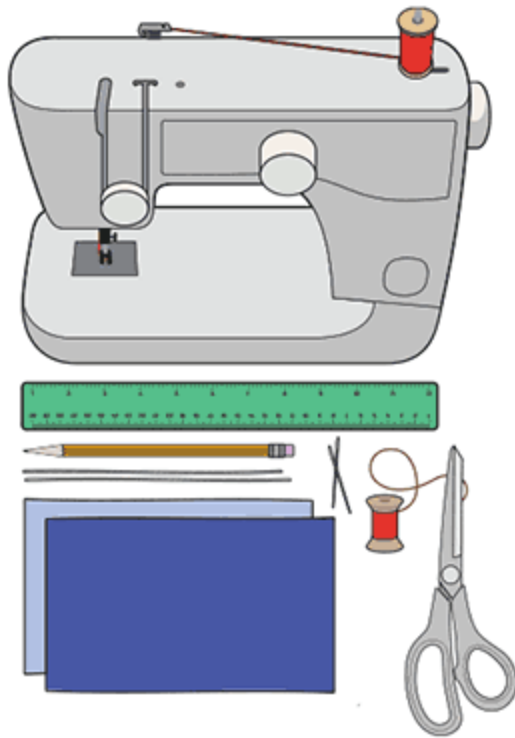

Sewn Cloth Face Covering

Materials

- Two 10"x6" rectangles of cotton fabric
- Two 6" pieces of elastic (or rubber bands, string, cloth strips, or hair ties)
- Needle and thread (or bobby pin)
- Scissors
- Sewing machine

Tutorial

1. Cut out two 10-by-6-inch rectangles of cotton fabric. Use tightly woven cotton, such as quilting fabric or cotton sheets. T-shirt fabric will work in a pinch. Stack the two rectangles; you will sew the mask as if it was a single piece of fabric.

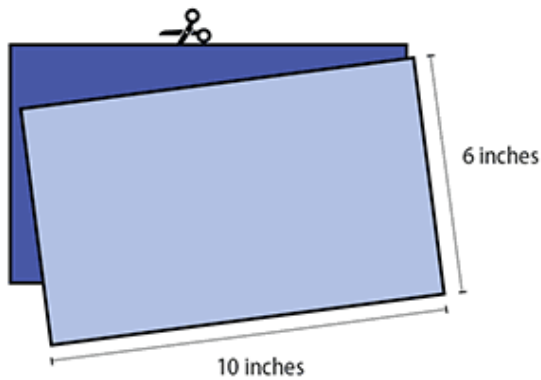

2. Fold over the long sides $\frac{1}{4}$ inch and hem. Then fold the double layer of fabric over $\frac{1}{2}$ inch along the short sides and stitch down.

3. Run a 6-inch length of $\frac{1}{8}$ -inch wide elastic through the wider hem on each side of the mask. These will be the ear loops. Use a large needle or a bobby pin to thread it through. Tie the ends tight.

Don't have elastic? Use hair ties or elastic head bands. If you only have string, you can make the ties longer and tie the mask behind your head.

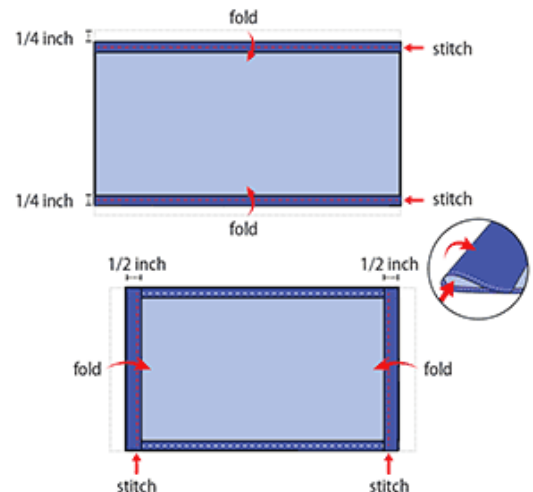

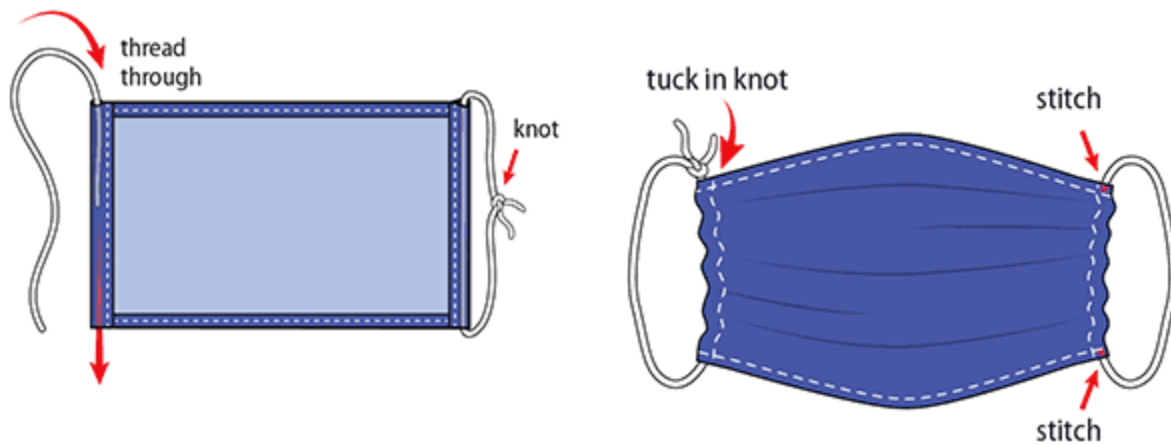

4. Gently pull on the elastic so that the knots are tucked inside the hem. Gather the sides of the mask on the elastic and adjust so the mask fits your face. Then securely stitch the elastic in place to keep it from slipping.

Quick Cut T-shirt Face Covering (no sew method)

Materials

- T-shirt
- Scissors

Tutorial

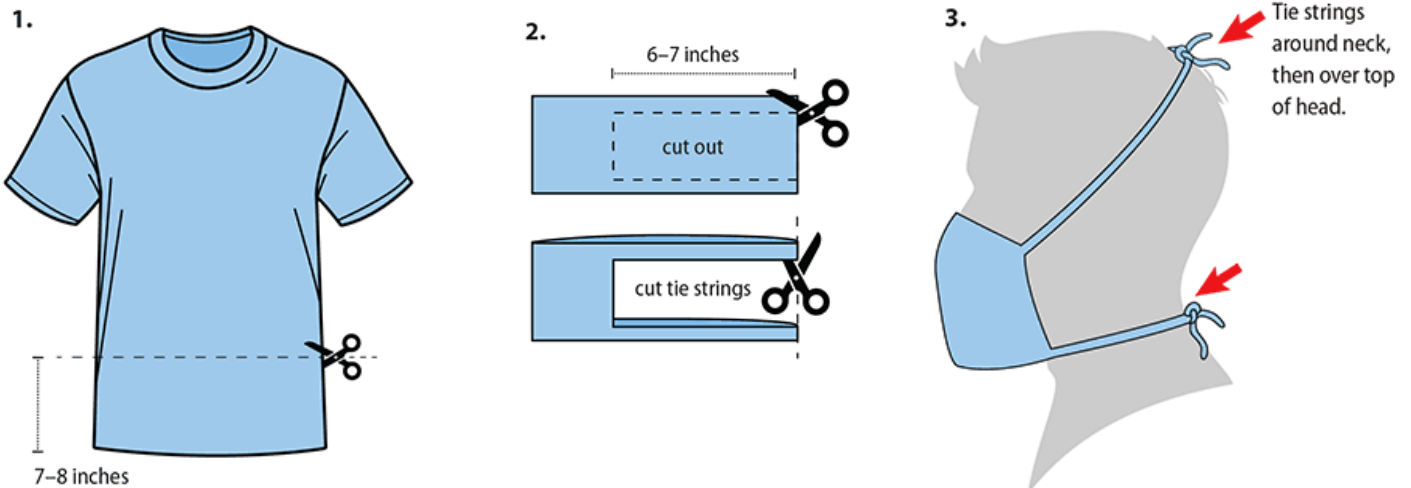

Bandana Face Covering (no sew method)

Materials

- Bandana (or square cotton cloth approximately 20"x20")
- Rubber bands (or hair ties)
- Scissors (if you are cutting your own cloth)

Tutorial

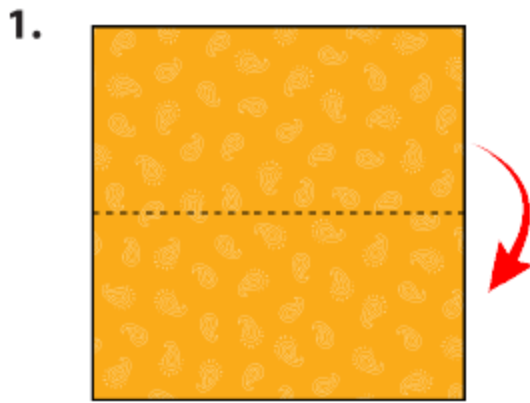

Fold bandana in half.



Fold top down. Fold bottom up.

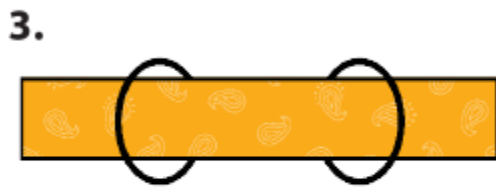

Place rubber bands or hair ties about 6 inches apart.

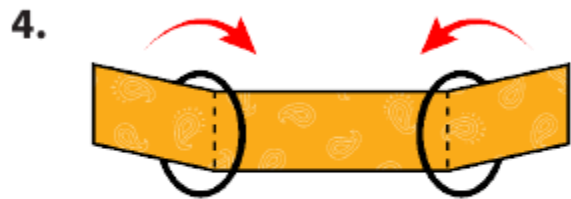

Fold side to the middle and tuck.

